

# CERAMICA

Mutina

colours

sizes

technical features

packing

MU  
TIN  
A<sup>®</sup>

**CERAMICA / all colours**



**CERAMICA / all colours sizes**

**design** Silvia Giacobazzi 2010  
**production** artisanal  
**material** impasto trafilato smaltato - glazed extruded body  
**thickness** 11 mm  
\*misure nominali - nominal sizes

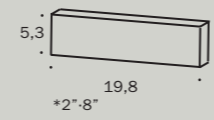

**complementary pieces**

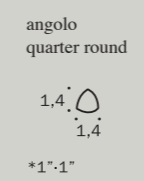
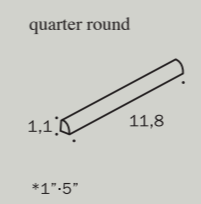

**CERAMICA / bianca**

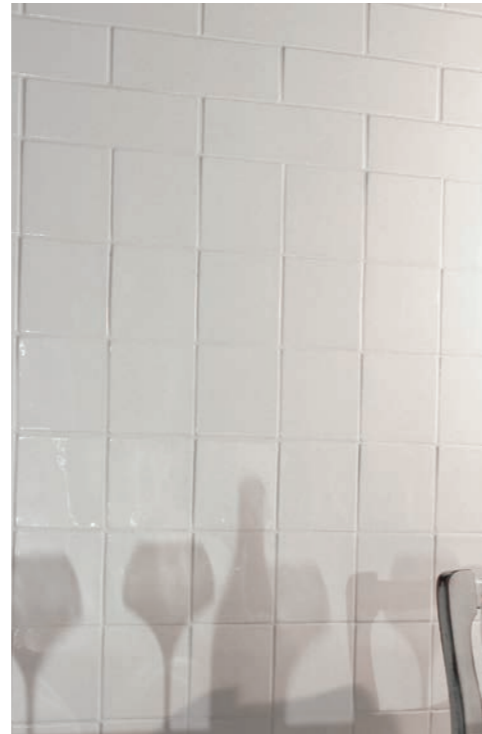

**CERAMICA / bianca sizes**

**design** Silvia Giacobazzi 2006

**production** artisanal

**material** impasto trafilato smaltato - glazed extruded body

**thickness** 11 mm 16 mm convessa

\*misure nominali - nominal sizes

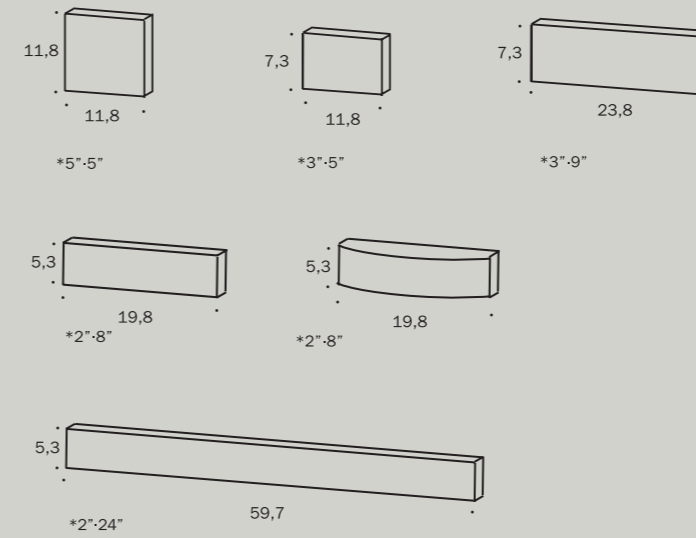

**complementary pieces**

quarter round

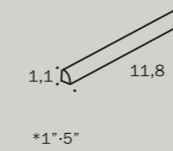

angolo  
quarter round

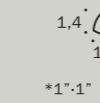

convessa terminale

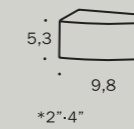

## CERAMICA / technical features

### AIII GROUP

norma standard	caratteristiche features	valore prescritto value required	ceramica
<b>ISO 10545/3</b>	assorbimento d'acqua water absorption	≤ 10%	11%
<b>ASTM C373</b>			11%
<b>ISO 10545/11</b>	resistenza al cavillo crazing resistance	nessuna alterazione visibile no visible alteration	resiste resistant
<b>ISO 10545/12</b>	resistenza al gelo frost resistance	nessuna alterazione visibile no visible alteration	non resiste resistant
<b>ASTM C1026</b>		unaffected	affected
<b>ISO 10545/13</b>	resistenza agli attacchi chimici resistance to chemical attacks	nessuna alterazione visibil no visible alteration	resiste resistant
<b>ASTM C650</b>			unaffected
<b>ISO 10545/14</b>	resistenza alle macchie stains resistance	classe 3 min	classe 5
<b>ISO 10545/15</b>	cessioni di piombo e cadmio migration of lead and cadmium	nessuna cessione no migration	nessuna cessione no migration

## CERAMICA / packing

formato size	pz-mq pcs-sqm	pz-scat. pcs-box	mq-scat. sqm-box	scat.-pal. box-pal.	kg-scat. kg-box	kg-pal. kg-pal.	mq-pal sqms-pal
11,8·11,8	71,82	50	0,70	60	13,00	780	42,00
7,3·11,8	116,00	80	0,69	60	13,00	780	41,40
7,3·23,8	57,50	56	0,97	45	17,20	774	43,65
5,3·19,8	95,29	65	0,68	64	12,50	800	43,52
5,3·19,8 convessa	95,29	50	0,52	64	12,50	800	33,28
5,3·59,7	31,60	20	0,63	60	11,90	714	37,80
quarter round 1,1·11,8	-	-	-	-	-	-	-
angolo quarter round 1,4·1,4	-	-	-	-	-	-	-
convessa terminale 5,3·9,8	-	-	-	-	-	-	-



V1  
variazione uniforme  
uniform variation

**MUTINA.IT**

Follow us on

